



AUDIO EQUIPMENT

COMPLETE SCHOOL BUS SOLUTIONS



how-to guide

A step-by-step process for selecting the correct radio, PA system and accessories for your vehicle.

CONTENTS

- RADIOS 4
- RADIO COMPARISON 6
- PANEL-MOUNT PA SYSTEMS 7
- BLUE BIRD RADIO HARNESSES & ACCESSORIES 8
- THOMAS RADIO HARNESSES & ACCESSORIES 9
- IC RADIO HARNESSES & ACCESSORIES 10
- ADDITIONAL ACCESSORIES 11

Integrative solutions from an industry leader.

REI designs, engineers and services durable, integrative products and solutions for today's school bus operations. Customers rely on our innovative engineering to upgrade fleet communication, safety and entertainment.

- | | |
|-------------------------|--------------------------|
| Bus | Emergency Vehicle |
| Commercial | Ambulance |
| Motorcoach | Fire Truck |
| School | Mobile Command |
| Transit | Police |
| Commercial Truck | Agriculture |
| Delivery | Construction |
| Fleet | Dealers |
| Waste/Refuse | OEM |

REI is Superior

- One source for complete, engineered solutions
- Products are quality-tested to withstand years of rugged use
- Live 24/7/365 in-house Support

STEP 1

Identify the manufacturer, model and year of your vehicle.

STEP 2

Select a radio. (See pages 4-6.)



ST-4050



ST-5050



VR-5650

Add optional PA kit. (See pages 5, 7 and 14.)



STEP 3

Select a radio harness and accessories according to your vehicle manufacturer, model and year. (See pages 5-14.)

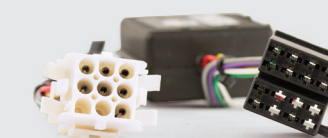

ST-4050 AM/FM Stereo Radio



- Smartphone/USB-enabled device charging
- Front Aux input for MP3, iPod and other portable media players
- Front type-A USB input

ITEM	PART #
ST-4050	710738

Add Optional ST-4050/ST-5050/VR-5650 PA Kit



480024

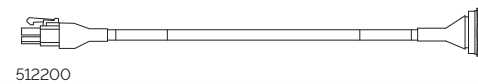

512200

ITEM	PART #
Carbon Microphone PA Kit	750322
Includes:	
Handheld Carbon Microphone with 3' Coiled Cable - 4 Pin Straight CB-Style Connector	480024
Microphone Mounting Clip	480201
3' Cable with 4 Pin Male Mini-Fit™ to Microphone Jack	512200

ST-5050 AM/FM/BT Stereo Radio



- Bluetooth® connectivity for audio streaming and hands-free calling
- Smartphone/USB-enabled device charging
- Front Aux input for MP3, iPod and other portable media players
- Rear type-A USB input

ITEM	PART #
ST-5050	710717

VR-5650 AM/FM/CD/DVD/MP3/BT Stereo Radio



- Bluetooth connectivity for audio streaming and hands-free calling
- Smartphone/USB-enabled device charging
- Front Aux input for MP3, iPod and other portable media players
- Rear type-A USB input

ITEM	PART #
VR-5650	710767

SURVEILLANCE & FLEET MANAGEMENT

REI solutions provide the critical details you need to advance fleet safety and efficiency. Capture and record ultrawide views. See down into seats. Integrate REI software to manage your vehicle data and video, quickly and easily.

Contact your REI representative today!

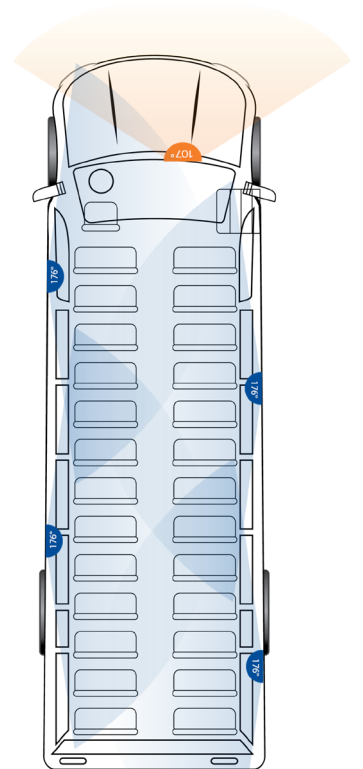

RADIO COMPARISON



	ST-4050	ST-5050	VR-5650
Power rating	50 Watts x 4	50 Watts x 4	50 Watts x 4
Compact Disc with anti-skip mechanism			●
MP3/WMA playback	●	●	●
WB (Weather Band)	●	●	●
USB			
Front-panel type-A input	●	●	
Rear type-A input		●	●
Smartphone charge port in USB MODE	● (1.5A)	● (1.5A)	● (1.5A)
Bluetooth®			
Audio streaming (A2DP)		●	●
Hands-free calling (HFD)		●	●
Smartphone/portable media player ¹			
Built-in smartphone charging	●	●	●
Built-in portable media player charging	●	●	●
Built-in portable media player controls	●	●	●
AUX			
Front panel connects iPods, MP3 players and portable media players	●	●	●
Rear / RCA audio input jack	●	●	●
PA			
Integrated PA	●	●	●
Dynamic microphone PA input	Selectable Menu-1 (4 pin)	Selectable Menu-1 (4 pin)	Selectable Menu-1 (4 pin)
Carbon microphone PA inputs	Selectable Menu-1 (4 Pin)	Selectable Menu-1 (4 Pin)	Selectable Menu-1 (4 Pin)
Adjustable PA zone output (front/rear/both)	●	●	●
Radio chassis connector	ISO	ISO	ISO
Preset stations	18 FM / 12 AM / 7 WB	18 FM / 12 AM / 7 WB	18 FM / 12 AM / 7 WB
USA/EURO radio frequency modes	●	●	●
Station presets stored during power loss	●	●	●
Clock	●	●	●
30-day clock backup	●	●	●
RDS text ²	●	●	●

¹ Earlier model iPods are not supported because they do not implement the USB control protocol. They may be connected to the radio using auxiliary inputs if available.

² Radio stations broadcasting RDS may not be available in your listening area.

PA systems

Panel-Mount PA Systems

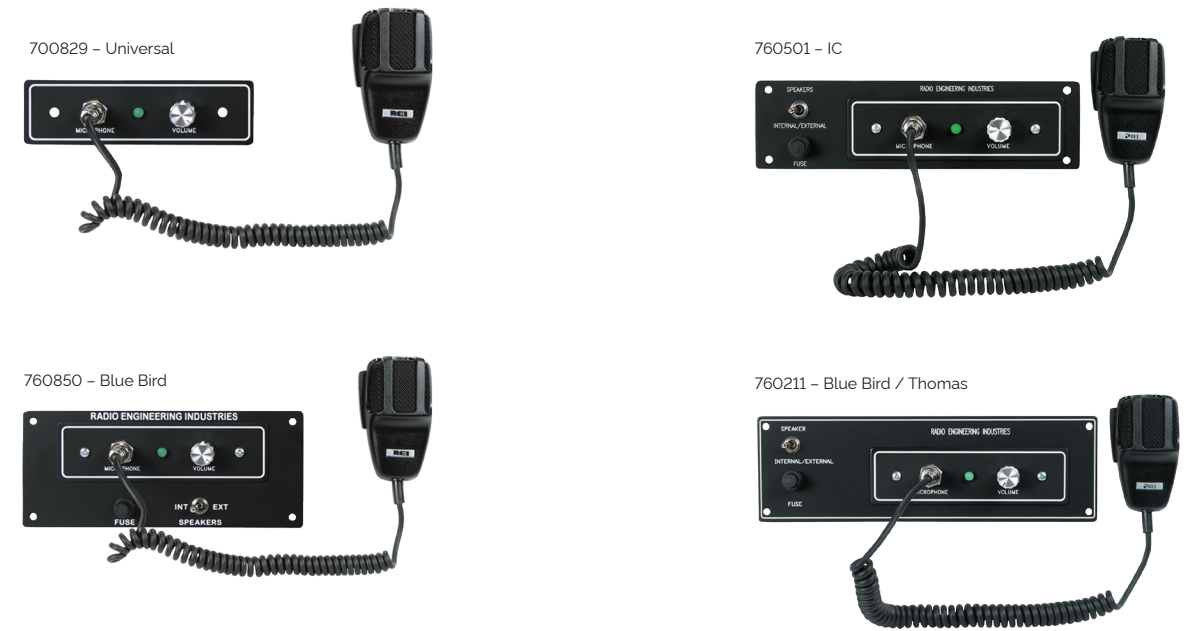

- 12 Volt
- 25-Watt power output
- Single channel
- Volume control
- Interior/exterior speaker selection (not included on 2' x 7" panel)

ITEM	PART #
Panel-Mount PA System - 2' x 7"	700829
Panel-Mount PA System - 2.875' x 10.5"	760501
Panel-Mount PA System - 4' x 9"	760850
Panel-Mount PA System - 4' x 12"	760211
Each PA System Includes:	
Handheld Carbon Microphone with 3' Coiled Cable - 4 Pin Straight CB-Style Connector	480024

BLUE BIRD

VEHICLE MODEL	RADIO ONLY	RADIO W/PA KIT	HARNESS/CONNECTOR	MOUNTING PLATE*	MIC EXTENSION CABLE
2001 and Newer					
All-American Series	ST-4050 ST-5050 VR-5650		512210 ISO Connector to 9 Pin Connector	610063 4" x 9" Mounting Plate	NA
		ST-4050 ST-5050 VR-5650	512215 ISO Connector to 9 Pin Connector with Interior-Exterior Panel Switch	610034 4" x 9" Mounting Plate	512129 20' Carbon Cable - 4 Pin Male Mini-Fit™ to Radio (4 Pin Female Mini-Fit™)
Vision Series	ST-4050 ST-5050 VR-5650		512210 ISO Connector to 9 Pin Connector	NA	NA
		ST-4050 ST-5050 VR-5650	512310 ISO Connector to 9 Pin Connector with Interior-Exterior Connector for Dashboard Rocker Speaker Selector Switch (not included)	NA	NA
Nov. 1999-Dec. 2000					
All-American Series	ST-4050 ST-5050 VR-5650		512210 ISO Connector to 9 Pin Connector	610063 4" x 9" Mounting Plate	NA
		ST-4050 ST-5050 VR-5650	512215 ISO Connector to 9 Pin Connector with Interior-Exterior Panel Switch	610034 4" x 9" Mounting Plate	NA
TC/2000	ST-4050 ST-5050 VR-5650		512210 ISO Connector to 9 Pin Connector	610087 4" x 12" Mounting Plate	NA
		ST-4050 ST-5050 VR-5650	512215 ISO Connector to 9 Pin Connector with Interior-Exterior Panel Switch	610032 4" x 12" Mounting Plate	NA

*A mounting plate is required for a radio mounted on a bulkhead above the driver. Radios mounted in dashes are DIN mounts and do not require mounting plates.

Blue Bird Harnesses

ST-4050, ST-5050 and VR-5650 with ISO Connectors

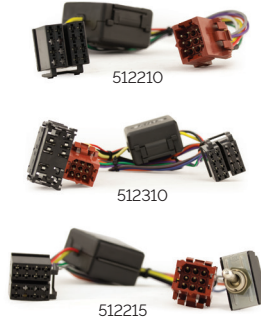

Blue Bird Mounting Plates

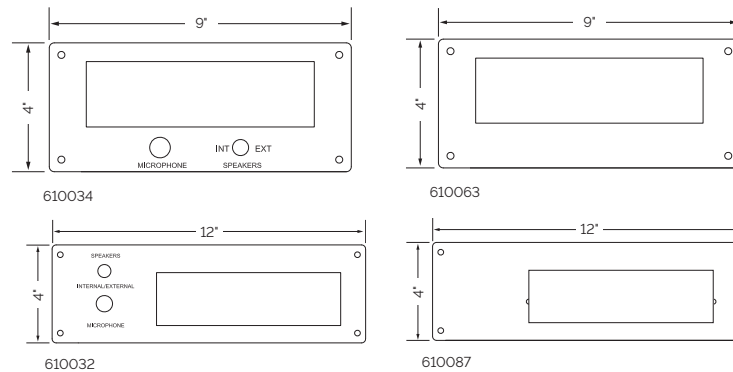

Blue Bird Mic Extension Cables



THOMAS

VEHICLE MODEL	RADIO ONLY	RADIO W/PA KIT	HARNESS/CONNECTOR	MOUNTING PLATE*
August 2003 and Newer				
Minotour, MyBus, Thomas/Freightliner FS-65, Saf-T-Liner Series	ST-4050 ST-5050 VR-5650		512256 ISO Connector to 14 Pin Mini-Fit™ Connector	NA
		ST-4050 ST-5050 VR-5650	512522 ISO Connector to 14 Pin Mini-Fit™ Connector Interior-Exterior Panel-Mount Speaker Selector Switch	NA
July 2003 and Earlier				
Conventional Prior to 1998, Saf-T-Liner Series Prior to 2000	ST-4050 ST-5050 VR-5650		512301 ISO Connector to 12 Pin Mini-Fit™ Connector	610087 4" x 12" Mounting Panel
		ST-4050 ST-5050 VR-5650	512521 ISO Connector to 12 Pin Mini-Fit™ Harness with Interior-Exterior Panel-Mount Speaker Selector Switch	610032 4" x 12" Mounting Panel
Minotour, Mighty Mite, Conventional After 1998, Vista, Saf-T-Liner Series After 2000, All Star EF	ST-4050 ST-5050 VR-5650		512301 ISO Connector to 12 Pin Mini-Fit™ Connector	NA
		ST-4050 ST-5050 VR-5650	512521 ISO Connector to 12 Pin Mini-Fit™ Harness with Interior-Exterior Panel-Mount Speaker Selector Switch	NA

*A mounting plate is required for a radio mounted on a bulkhead above the driver. Radios mounted in dashes are DIN mounts and do not require mounting plates.

Thomas Harnesses

ST-4050, ST-5050 and VR-5650 with ISO Connectors



Thomas Mounting Plates

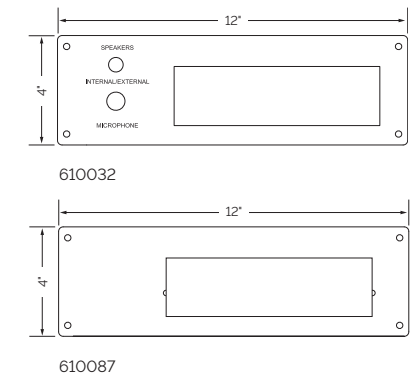

IC

VEHICLE MODEL	RADIO ONLY	RADIO W/PA KIT	HARNESS/CONNECTOR	MOUNTING PLATE*
2000 and Newer				
AE, BE, CE, FE, RE Series	ST-4050 ST-5050 VR-5650		512516 ISO Connector to 9 Pin AMP MATE-N-LOK Connector (Female Terminals)	610071 2.85" x 10.5" Mounting Panel
		ST-4050 ST-5050 VR-5650	512289 ISO Connector to 9 Pin AMP MATE-N-LOK Connector (Female Terminals) Interior-Exterior Panel-Mount Switch	610033 2.85" x 10.5" Mounting Panel
2000 and Earlier				
AE, FE, RE Series	ST-4050 ST-5050 VR-5650		512515 ISO Connector to 9 Pin AMP MATE-N-LOK Connector (Male Terminals)	610071 2.85" x 10.5" Mounting Panel
		ST-4050 ST-5050 VR-5650	512519 ISO Connector to 9 Pin AMP MATE-N-LOK Connector (Male Terminals) Interior-Exterior Speaker Selector Panel-Mount Switch	610033 2.85" x 10.5" Mounting Panel

*A mounting plate is required for a radio mounted on a bulkhead above the driver. Radios mounted in dashes are DIN mounts and do not require mounting plates.

IC Harnesses

ST-4050, ST-5050 and VR-5650
with ISO Connectors



IC Mounting Plates

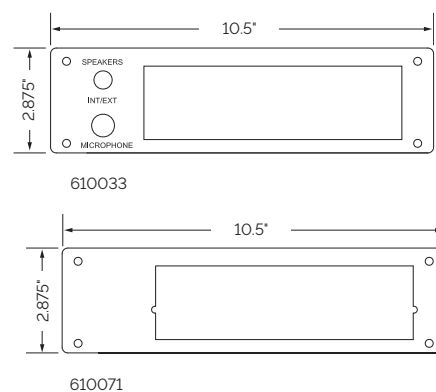

additional accessories

Antennas

Flexible AM/FM Universal-Mount Antenna

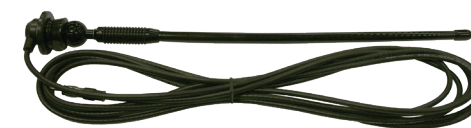

- Flexible, rustproof, wire-wound mast with rubber coating
- Split-ball adjustable base with included 60" antenna cable
- Male Motorola® plug

ITEM	PART #
Flexible AM/FM Antenna with 60" Cable	210066
Flexible AM/FM Antenna with 156" Cable	210125
Replacement Rubber Mast	210067

AM/FM Top/Side Universal-Mount Antenna

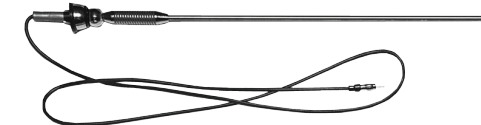

- Single-section 31" steel mast
- Universal top- or side-mount/heavy-duty spring
- Includes 54" antenna cable
- Mast adjustable to 180°
- Male Motorola® plug

ITEM	PART #
AM/FM Top/Side Universal-Mount Antenna	210098

AM/FM Steel-Mast Telescoping Antenna



- 96" 4-section telescoping steel mast
- Dual mounting points
- Includes 96" antenna cable
- Male Motorola® plug

ITEM	PART #
AM/FM Steel-Mast Telescoping Antenna	210000

Speakers

One-Piece Speaker with Grille

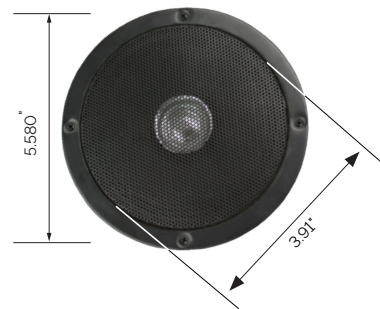

- Dual-cone speaker
- 30 Watts max power
- 4 OHMS impedance

ITEM	PART #
6" One-Piece Speaker with Grille	220026

4" Speaker

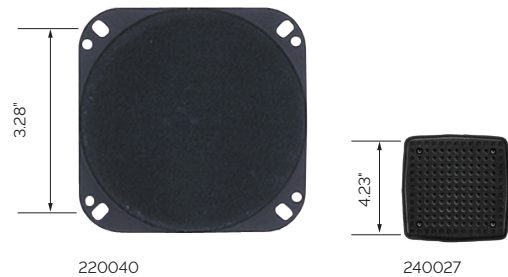

- Full-range speaker
- 30 Watts max power
- 4 OHMS impedance

ITEM	PART #
4" Speaker	220040
4" Grille	240027

Weather-Resistant Exterior Speakers



220022

- 15 Watts max power
- Aluminum housing
- 8 OHMS impedance
- Adjustable mounting bracket



220031PA

- 30 Watts max power
- 4 OHMS impedance
- Metal housing
- Adjustable mounting bracket

ITEM	PART #
5" PA Horn	220022
8" PA Horn	220031PA

Radio Harnesses



VEHICLE	RADIO	VEHICLE CONNECTOR	PART #
Generic	ST-4050, ST-5050 and VR-5650 with ISO Connector	Bare Wires	512202

USB Input Extension



- USB 2.0
- 10" cable
- Panel mount

ITEM	PART #
USB Input Extension for ST-5050 and VR-5650	512485

Audio Cable



ITEM	PART #
6' Cable - 3.5 mm Male to Male Slim-Plug Shielded Audio Cable	530169

DRIVER ASSISTANCE

Protect students, drivers and vehicles from the unexpected. REI driver assistance systems can be the 'extra set of eyes' you need for blind-spot coverage, lane-change assistance, backing-up views and improved day/night visibility.

3D 360° System



Standard Camera Observation System



Call your REI representative today!

Antenna Extension Cables

Motorola Female to Motorola Male Plugs

ITEM	PART #
24" Extension Cable	530013
36" Extension Cable	530015
48" Extension Cable	530001
60" Extension Cable	530043
96" Extension Cable	530003
144" Extension Cable	530004
240" Extension Cable	530044

Carbon Microphone Jacks

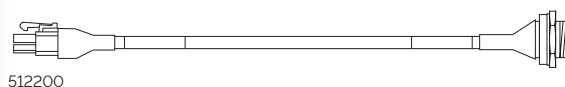
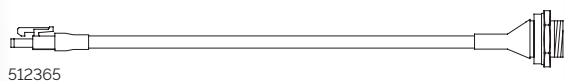

Thru-Hole Mount

ITEM	PART #
3' Cable - Carbon 4 Pin CB-Style Microphone Jack to Radio (3 Pin Female Mini-Fit™)	512365
3' Cable - Carbon 4 Pin CB-Style Microphone Jack to Radio (4 Pin Female Mini-Fit™)	512200

Carbon Extension Cables

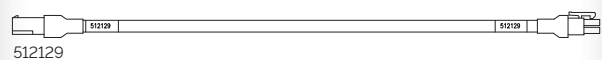
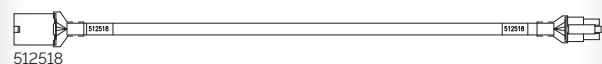

ITEM	PART #
20' Carbon Cable - 3 Pin Male Mini-Fit™ to Radio (3 Pin Female Mini-Fit™)	512518
20' Carbon Cable - 4 Pin Male Mini-Fit™ to Radio (4 Pin Female Mini-Fit™)	512129

Carbon Handheld Microphones



ITEM	PART #
Handheld Microphone with 3' Coiled Cable - 4 Pin Straight CB-Style Connector <i>Includes:</i> Microphone Mounting Clip (480201)	480024
Handheld Microphone with 3' Coiled Cable - 5 Pin Straight CB-Style Connector <i>Includes:</i> Microphone Mounting Clip (480201)	480271
Microphone Mounting Clip	480201

Carbon Microphone Connectors

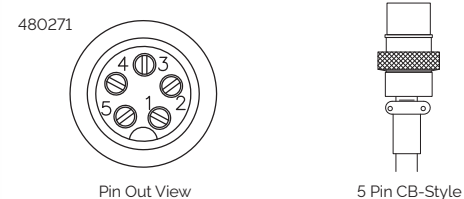
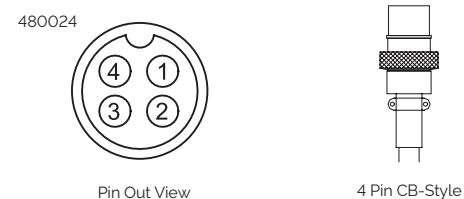

For additional products, contact REI at 800.228.9275.



REI[®]

6534 L Street, Omaha, NE 68117
800.228.9275 | 402.339.2200
radioeng.com | 24/7/365 Support